









**IMO Wall valve anti-clockwise closing 1/2" - Chrome**

IMO

36 607 980

- rosette 60 x 60 mm
- head part with cut-to-length spindle and sleeve



	Chrome	36 607 980-00
	Brushed Platinum	36 607 980-06
	Platinum	36 607 980-08
	Dark Chrome	36 607 980-19
	Brushed Durabronze (23kt Gold)	36 607 980-28
	Matte Black	36 607 980-33
	Brushed Chrome	36 607 980-93
	Brushed Dark Platinum	36 607 980-99

**Required miscellaneous**

- |  |                           |               |
|--|---------------------------|---------------|
|  | <b>Wall valve 1/2" -</b>  | 35 607 970 90 |
|  | •max. recess depth 145 mm |               |
|  | •min. recess depth 75 mm  |               |

36 607 980

mm [inches]

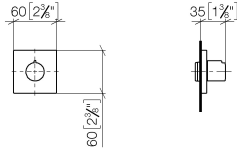

Certificates

DVGW\_DW-  
6501DN0116.

WRAS\_2011026.

IAPMO\_4976 (1).

LGA\_29931.

WRAS\_2010066.

DVGW\_DW-  
6512DN0706.

LGA\_29932.

36 607 980

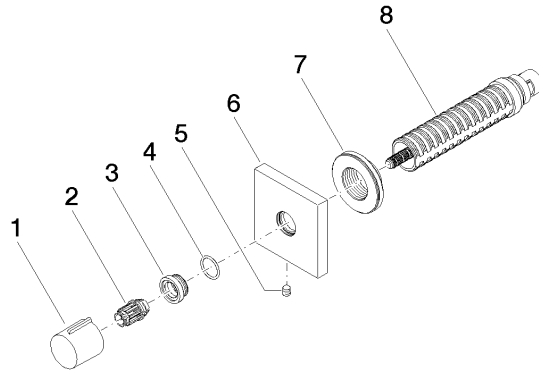

### Spare parts list

No.	Item Number	Name	Quantity used	Delivery time
1	09 20 98 001-00	handle	1	10
2	09 12 12 005 90	fixing cap	1	2
3	09 12 12 043-00	base	1	10
4	09 14 10 017 90	seal	1	2
5	90 31 11 004 00 90	pin	1	2
6	09 27 98 014-00	rosette	1	10
7	09 21 02 151 90	sleeve	1	2
8	90 90 03 202 00 90	top	1	2